

AMANO

ELECTRONIC TIME RECORDER

EX9000 series

OPERATION MANUAL

AMANO Corporation
275 MAMEDO CHO KOHOKU KU YOKOHAMA JAPAN TEL(045)401-1440 FAX(045)401-0034

AMANO ELECTRONICS OF AMERICA, INC.
1485 N. Manassero Street, Anaheim, CA. 92807. U.S.A.

NEW JERSEY OFFICE
80 Little Falls Road, Fairfield N.J. 07006, U.S.A.

LOS ANGELES OFFICE
3071 E. Ceena Court, Anaheim, CA 92806, U.S.A.

CHICAGO OFFICE
650 Grand Avenue, #304 Elmhurst, ILL. 60126, U.S.A.

DALLAS OFFICE
2156 West Northwest, Highway, Suite 314, Dallas, TX. 75220, U.S.A.

ATLANTA OFFICE
8601 Dunwoody Place, Suite 340 Atlanta, GA. 30350, U.S.A.

NEW YORK OFFICE
1180 Avenue of the Americas Suite 820, New York, N.Y. 10036, U.S.A.

TORONTO OFFICE
2740 Matheson Boulevard East, Unit #4 Mississauga, Ontario L4W 4X3, Canada

AMANO ELECTRONICS EUROPE N.V. HEAD OFFICE & GENK FACTORY
Westerring 2, 3600, Genk, Belgium

AMANO ELECTRONICS EUROPE N.V. BRUSSELS OFFICE
31 Vuurberg, Diegem 1831, Belgium

AMANO DEUTSCHLAND GMBH
Stadionring 32-4030 Ratingen 1, German.

PIONEER/ECLIPSE CORPORATION
Eclipse Road, Sparta, North Carolina, 28675, U.S.A.

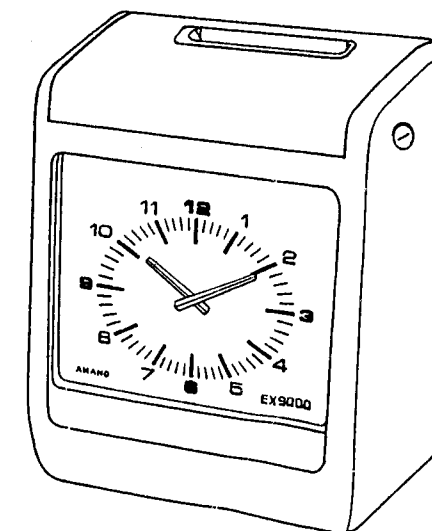

Contents

[EX9000]

INTRODUCTION

Introduction	1
List of EX9000 Series	1
Accessory	2
Product Specification	2

BEFORE OPERATION

Place of Installation	3
Power Source	3
How to Remove the Front Case	4
Connection of Battery (Full Power Reserve) (option)	5
How to Install on Wall	6
Name and Function of Each Part	7
Initial Value	8

HOW TO OPERATE

.....	10
TIMECARD	11
List of Types of Time Card	12
Adjustment to Card Width	18
Adjustment of Side Margin	18
Adjustment to Card Thickness	19
Adjustment of Slot Depth	19

TIME SIGNAL

Connection of Time Signal Line <EX9050, EX9200, EX9500>	20
---	----

SETTING METHOD

Setting	21
Setting of Date	22
Setting of Time	23
Print Column Change-over Time (In the case of 1-row-a-day card)	24
Print Column and Morning/Afternoon Change-over Time (In the case of 2-row-a-day card)	25
Setting of Pay Period Ending Date and Blank Row (In the case of Monthly Pay)	26
Setting of Pay Period Ending Day of the Week and Current Week (In the case of Weekly Pay)	27
Setting of Daylight Saving Time (to month and day)	28
Setting of Daylight Saving Time (to month and day of which week)	29
Time Signal Duration <EX9050, EX9200, EX9500>	30
Print Format	31
Setting of 2-color Printing <EX9200, EX9500>	34
Setting of Time Signal <EX9050, EX9200 and EX9500>	35
Setting of Print Column <EX9500>	36
Setting of RESTRICTED ZONE <EX9500>	37
Example of Main Settings	38
Example of Main Setting (Copying of Weekly Program)	39

MODIFICATION OF SET DETAILS OF WEEKLY PROGRAM

Modification (or Confirmation) of Weekly Program	40
Additional Setting	41
Cancellation of Set Details	41

MAINTENANCE

Change of Ribbon	42
Under Specific Situations	43
Daily Maintenance	43

APPENDIX

.....	44
Index of Items for Setting	44
Weekly Program Setting List	45

INTRODUCTION

We hope you will read this instruction manual and operate EX9000 Series correctly so as to let them operate fully efficiently for a long time.

- ◆ Please note that specification, appearance, descriptions, etc. may be subject to change due to improvement of product.
- ◆ This manual has been prepared very carefully, but, if you find any error or descriptions which you cannot understand clearly, please contact the dealer from whom you have bought our EX9000 Series.

List of EX9000 Series

	EX9000	EX9050	EX9200	EX9500
1-color printing	◎	◎		
2-color printing			◎	Q
Time signal		Q	Q	Q
Shift of print column				Q
Monthly pay, vertical weekly pay	Q	◎	Q	Q
Horizontal weekly pay				◎
Full power reserve	OP	QP	OP	OP
Column dividing sensor	☆		☆	☆
Party line function	*	☆	☆	☆
Two time signal circuits				

OP : Optional : Available at dealers at the time of purchase.

☆ : Extension : Since expansion functions are assembled in during production process in our plant, please inform us in advance that you need the expansion functions. It is sometimes impossible to assemble the expansion function in your unit or to replace your unit after purchase.

Accessory

After unpacking the package of EX9000 Series, please check all the accessories.

■ Instruction Manual

■ Key

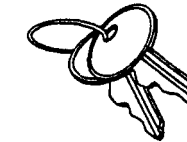
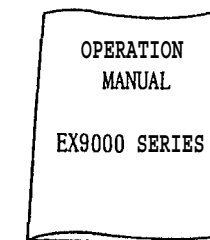

Production Specification

Power source	: 100VAC, 120VAC, 220VAC, 240VAC ± 10% (50 or 60Hz)
Power consumption	: Ordinary 5W, Maximum 30W
Environmental conditions	: Temperature : -10°C to 45°C Humidity : 10% to 90%RH (without dew condensation)
Outside dimensions	: 260(W) × 180(D) × 320(H)
Weight	: 3.5 kg
Clock system	: Crystal oscillator, Accuracy ± 3 seconds (20°C to 30°C) a week
Power compensation at the time of power failure	: For 3 years of accumulated power failure time with lithium battery (All functions other than the inner clock stop.).

Full power reserve

When the battery is fully charged, the followings are compensated:

- 1) For less than 72 hours of clock motion, 2-color selection, shift of print column, time signal or melody.
- 2) 200 times of printing, but within 72 hours.

When the unit is operating on the full power reserve, the attendance/leaving lamp goes on and off.

BEFORE OPERATION

Place of Installation

To use the unit for a long time, do not install it at the places mentioned below:

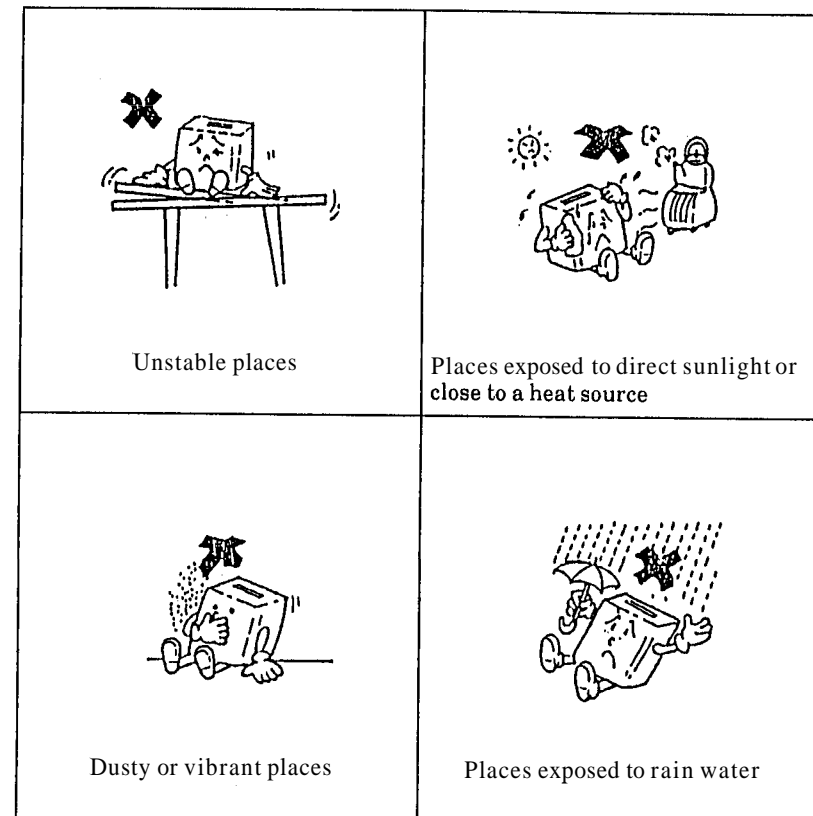

Power Source

- Check the AC power commercially available in your district. (100VAC, 120VAC, 220VAC, or 240VAC)
- Select such places where supply voltages are stable.
- Make the power available all the day from the power source, which should be independent from other equipment.
- The unit contains a lithium battery inside, and the inner clock keeps running. (For 3 years of accumulated power failure time.)

How to Remove the Front Case

The front cover should be removed when setting the battery (full power reserve), connecting the time signal cord and when hanging the unit on a wall.

☆ Before removing the front case, be sure to pull off the power cable from the plug receptacle.

1. Turn the key to the arrow direction.

2. Open the top cover.

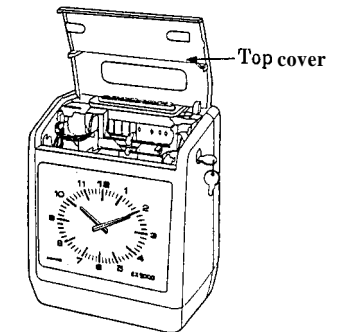
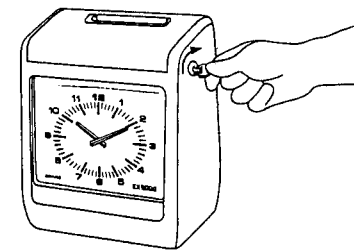

3. Remove the connector as shown below:

4. Face the backplate of the unit to the ground.

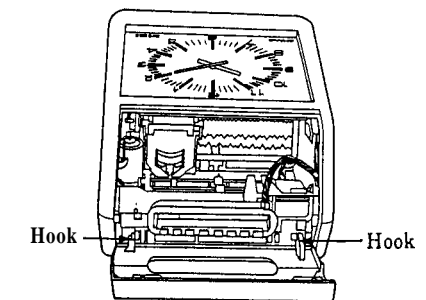
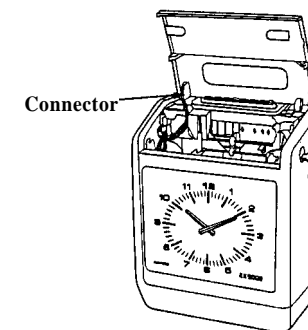

5. Widen the upper right and left hooks by force and lift the front case to remove it.

• Before closing the front case, connect the connector removed in the Procedure 3.

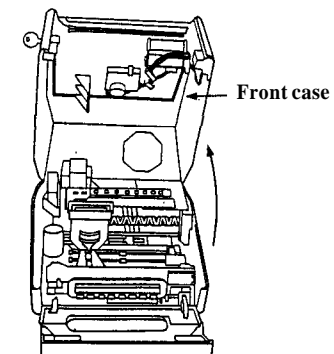

When removing the front case, be sure to face the backplate of the unit to the ground (unless hung on a wall). When the front case is removed without turning it aside, the rear case may fall down.

Connection of Battery (Full Power Reserve) (Option)

1. Pull off the power cable from the plug receptacle, face the backplate to the ground, then remove the connector and the front case from the unit.
2. Insert a battery connector in place. Make sure that the inserting direction is correct.

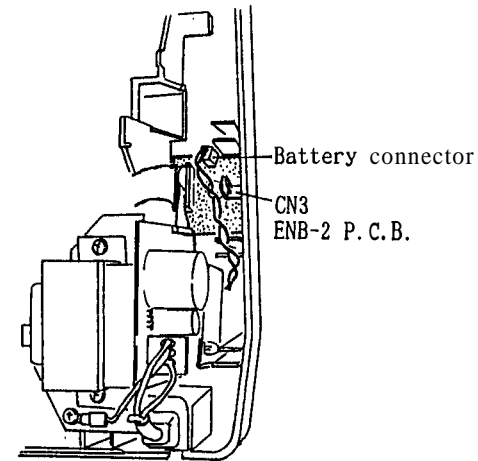
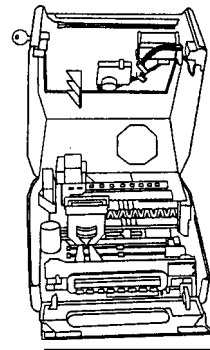

3. Set the front case to the unit, insert the connector in the unit, then close the top cover.

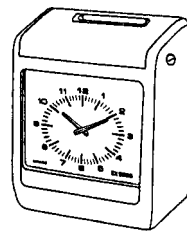

In addition to the battery, a lithium battery is also included in the unit, and the inner clock keeps running.

Therefore, when you insert the power cable in the plug receptacle after connection of the battery, the unit keeps running.

[Note] Use care to insert the battery connector to the correct direction. If it is inserted to the other direction, the unit may get out of order.

How to Install on Wall

1. Pull off the power cable from the plug receptacle, face the backplate to the ground, then remove the connector and the front case from the unit.
2. Fix a 5.1mm wood screw at the "A" position shown below on the wall and leave a space of 4mm or 5mm between the wall and the screw head.

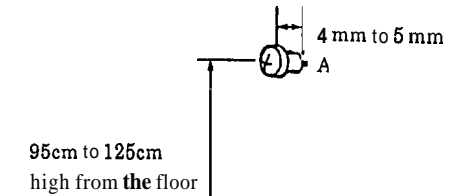
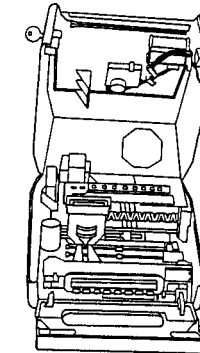

3. Hang the unit on the wood screw so that the wood screw enters the pobellied hole on the back of the unit.
4. Fix the unit with wood wcrews at three more places.

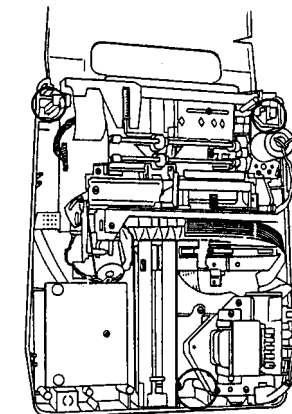
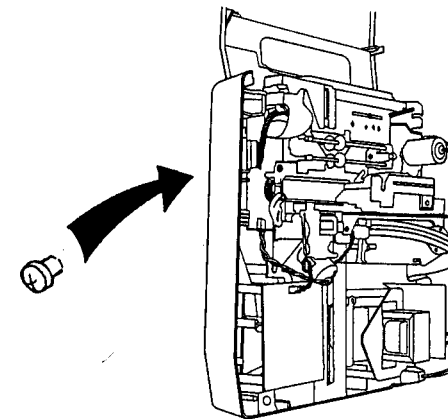

5. Set the front case to the unit, insert the connector in the unit and close the top cover.

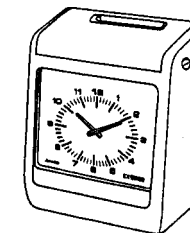

Precaution concerning Installing Method and Wall Material

When the unit is installed on a wall made of soft material like gypsum board, plywood, etc., the wood screw will become loose and the unit may drop from the wall during operation. So, set a plate between cleats, and fix the unit on the plate. (Prepare an appropriate plate before installation.)

Name and Function of Each Part

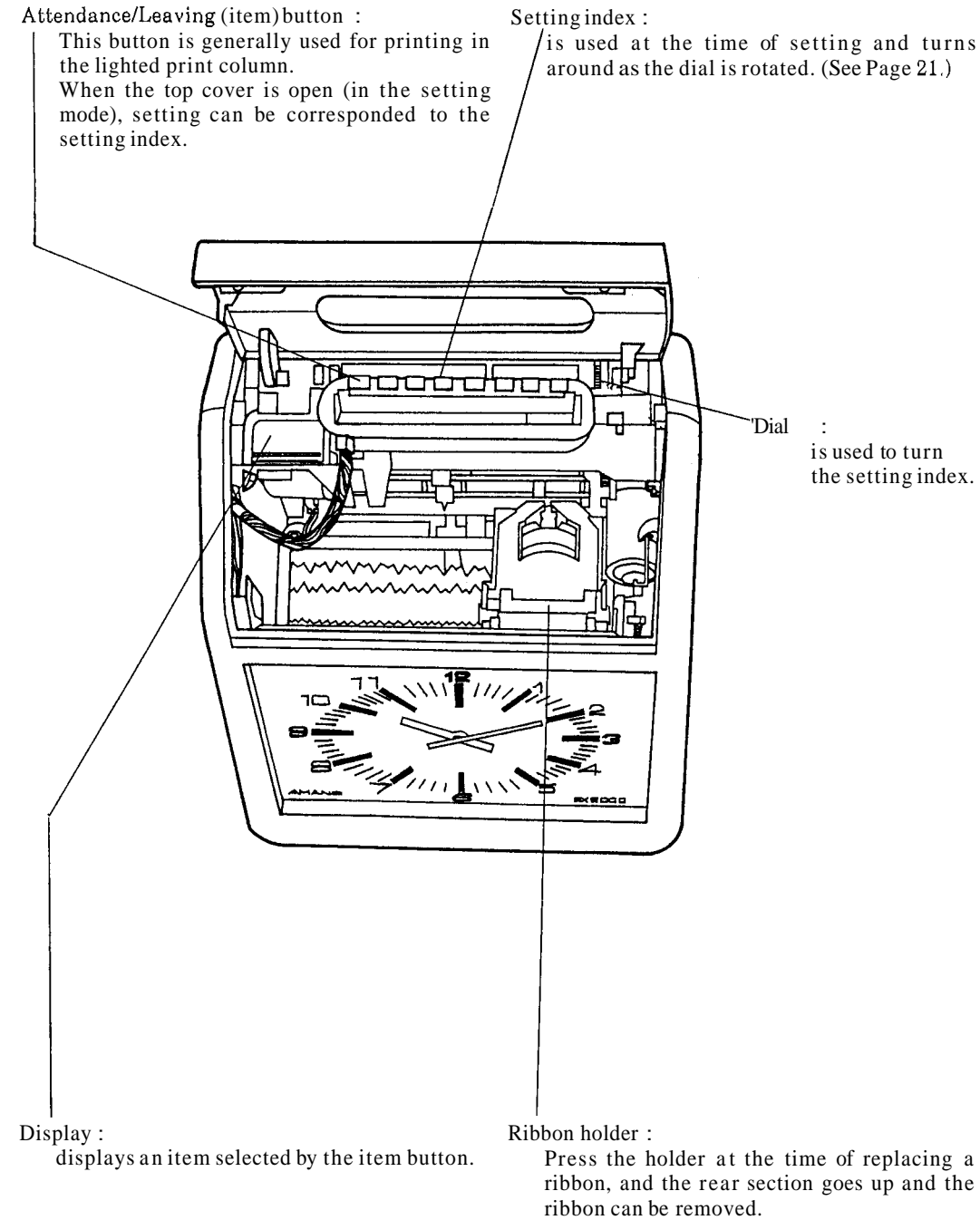

Initial Value

Items	Set points	Initial values
Print column change-over time	Hour : 00 to 23 Minute : 00 to 59	03:00
	1: Date change-over 2: Morning/Afternoon change-over (2-column-a-day card)	1
	Hour : 00 to 23 Minute : 00 to 59	1: 03:00 2: 12:00
Pay period ending date, empty column	(Monthly pay): 01 to 31 Empty column 01 to 32	31 01
	(Weekly pay): MANDAY (1) to SUNDAY (7)	5
	Current week: 1, 2 Bi-weekly pay is only set.	1
Start (End) of daylight saving time	Change-over method 0: No function 1: For setting month and date. 2: For setting month and day of the week	0
	Month: 01 to 12, Day: 01 to 31	--
	Week: 1 to 5 Day of the week: Monday to Sunday To set day of which week	-
Time signal duration	To decide time signal duration in seconds: 00 to 59 (sec.) <EX9050, EX9200, EX9500> No time signal is output for 00 (sec.)	05
Print format	Manual selection of print column <EX9500 (Vertical monthly pay and vertical weekly pay only)> 0: Manual selection possible 1: Manual selection impossible	0
	Double stamping prevention <EX9500 (Vertical monthly pay and vertical weekly pay only)> 0: Ineffective 1: Effective	0
	Printing of day of the week 0: Date 1: English 2: Spanish 3: French 4: German 5: Italian 6: Japanese 7: Day No. 8: No printing	0: Monthly pay 1: Weekly pay
	Printing of time 1: 24 hours (0 - 23 hours) (0 is not printed at the ten's place of hour.) 2: 12 hours (AM/PM hours) 3: 24 hours (0 - 23 hours) (0 is printed at the ten's place of hour.)	1

Items		Set points	Initial values
Print format		Printing of minute 1: Minutes 2: 1/100 hour A 3: 1/100 hour B 4: 1/10 hour	1
Weekly program I	2-color printing	To decide details for each print color <EX9200, EX9500> R: Start of printing in red B: Start of printing in black	R
	Time signal	To decide time signal circuit <EX9050, EX9200, EX9500> 0: No time signal is given. 1: Time signal is given to Circuit 1. 2: Time signal is given to Circuit 2 (extension). 3: Time signal is given to Circuits 1 and 2 (extension).	1
Weekly program II	Print column	To decide print column. <EX9500 (Vertical monthly pay and vertical weekly pay only)> 00 to The MAX column of each card type. 00: No print column is shifted.	00
	Restricted zone	To decide the time zone for double stamping prevention. <EX9500 (Vertical monthly pay and vertical weekly pay only)> 01: Starting time of double stamping prevention 02: Finishing time of double stamping prevention	01

HOW TO OPERATE

- Select a print column with the attendance/leaving button, insert a card, and it is possible to print in the column where the button is lit.
- In the case of <EX9500> for which print columns can be shifted, print columns are shifted as time passes. (When another column is selected with the attendance/leaving button, the column is replaced by the original column after printing or after ten seconds.)

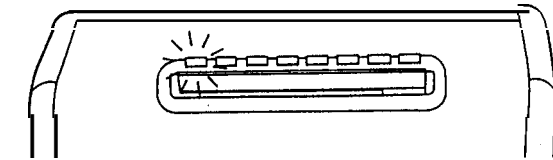

- Since card is automatically pulled in, do not push it in or do not pull it out.

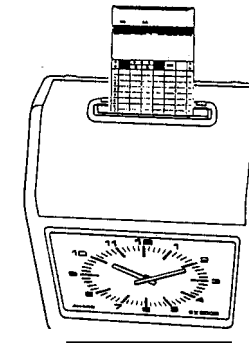

During Power Failure

When power supply is suspended, everything except the inner clock stops. When the power supply is restored, everything returns to normal. → The lithium battery is effective for three years of accumulated power failure time. (When a full power reserve [Option] comes not to function, the duration is counted in the three years.)

At the time of power failure

If a full power reserve functions,

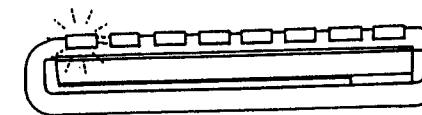

The attendance/leaving lamp goes on and off.

If a full power reserve does not function,

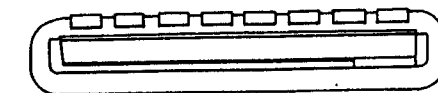

The attendance/leaving lamp goes out.

Full Power Reserve

can compensate clock motion, 2-color selection, shift of print column, time signal or melody for 72 hours, or 200 times of printing within 72 hours (when fully charged).

Card type code	4	5
Card type	14 lifts across the card bi-weekly	14 lifts across the card weekly ND1
Card width (mm)	86 mm	82.5 mm
Number of columns	6 columns	4 columns
Number of lines	14 lifts	7×2 lifts
Column pitch (mm)	12 mm	12 mm
Line pitch (mm)	6 mm	6 mm×2
Side margin (mm)	mm (1st week)/7.5 mm (2nd week)	16 mm
Applicable models	EX9000, EX9050, EX9200, EX9500	
Sample		

Card type code	6	7
Card type	Monthly pay, 16/16 lifts, 2 sides Amano standard card	Monthly pay, 15/16 lifts, 1 sides
Card width (mm)		
Number of columns	6 columns	3×2 columns
Number of lines	16 lifts	
Column pitch (mm)	12 mm	
Line pitch (mm)		
Side margin (mm)	7 mm (Front)/7 mm (Back)	7 mm (Left)/43 mm (Right)
Applicable models		
Sample		

Card type code	8	9
Card type	Monthly pay, 31 lifts	TAB card 16 lifts down/up the card, weekly
Card width (mm)	104mm	82.55 mm
Number of columns	6 columns	7 columns
Number of lines	31 lifts	16 lifts
Column pitch (mm)	12mm	10.55mm
Line pitch (mm)	4.53 mm	6 mm
Side margin (mm)	8mm	4 mm
Applicable models		
Sample		

Card type code	10	11	12
Card type	TAB card 22 lifts down/up the card, weekly	16 lifts down/up the card, weekly	22 lifts down/up the card, weekly
Card width (mm)	82.55 mm	98 mm to 106mm	
Number of columns	7 columns		
Number of lines	22 lifts	16 lifts	22 lifts
Column pitch (mm)	10.55mm	12 mm	
Line pitch (mm)	4.35 mm	6 mm	4.35 mm
Side margin (mm)	4 mm	7 mm	
Applicable models			
Sample			

Card type code	13	14
Zard type	16 lifts dowdup the card, monthly	22 lifts dowdup the card, monthly
Zard width (mm)	98 mm to 106 mm	
Number of columns	8 columns	
Number of lines	16 lifts	22 lifts
Column pitch (mm)	12 mm	10.7 mm
Line pitch (mm)	6 mm	4.35 mm
Side margin (mm)	8 mm (Front)/8 mm (Back)	7 mm (Front)/ 7 mm (Back)
Applicable models	EX9500	
Sample		

Adjustment to Card Width

1. Pull off the power cable from plug receptacle, face the backplate of the unit to the ground and remove the connector and the front case.
2. Loosen three screws indicated in the figure with a Phillips type screwdriver and adjust the slot width to the one of card to be used. The width can be adjusted in the range from 82.5mm to 106mm.

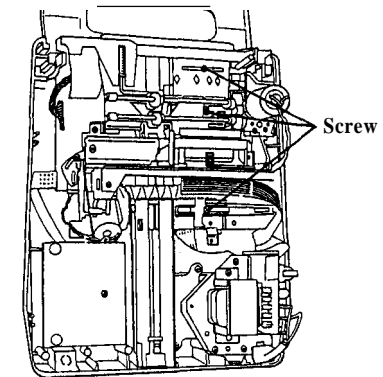
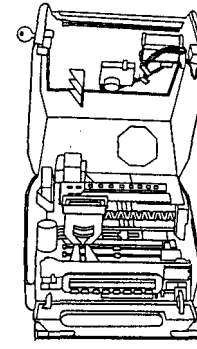

Adjustment of Side Margin

1. Pull off the power cable from the plug receptacle, face the backplate of the unit to the ground and remove the connector and the front case.
2. After having removed the case, hold the section indicated by hand from below, loosen it with a Phillips type screwdriver and adjust the side margin. (Scales are indicated.) The adjusting range extends from 3mm to 15 mm.

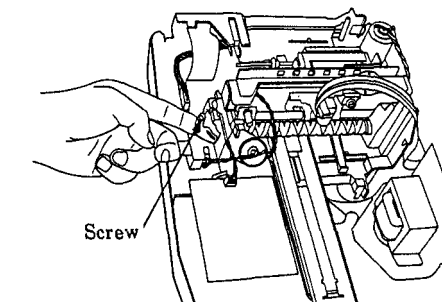
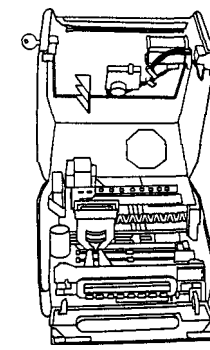

Adjustment to Card Thickness

1. Pull off the power cable from the plug receptacle, face the backplate of the unit to the ground and remove the connector and the front case.
2. After having removed the case, turn both right and left dials to adjust the back and forth width of the slop. (Scales are indicated.) The adjusting range extends from 0.188mm to 0.9 mm. At the time of shipment, this width is set to 0.37 mm.

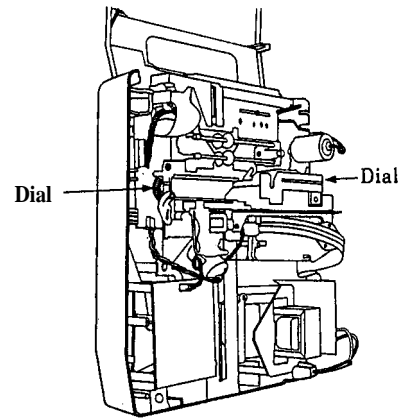
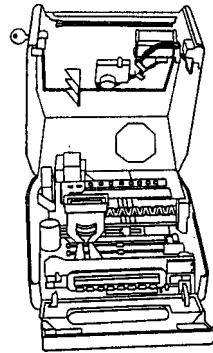

Adjustment of Slot Depth

1. Pull off the power cord from the plug receptacle, face the backplate of the unit to the ground and remove the connector and the front case.
2. After having removed the case, loosen the section indicated in the figure with a Phillips type screwdriver and adjust the depth. (Scales are indicated.) The adjusting range extends from 17mm to 31mm.

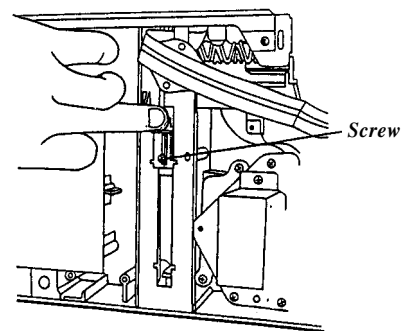
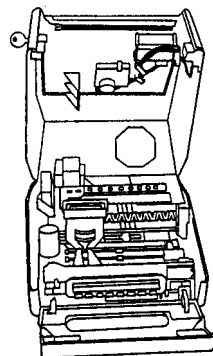

TIME SIGNAL

Connection of Time Signal Line

1. Pull off the power cable from the plug receptacle, face the backplate of the unit to the ground and remove the connector and the front case.
2. Pass the time signal line through the rear case left bottom.

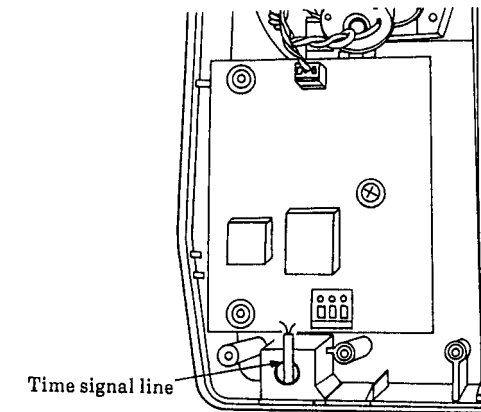
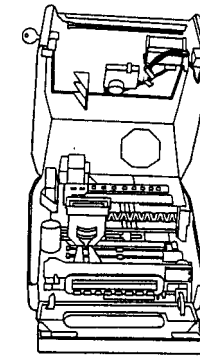

3. Press the protrusion on the top of the time signal terminal and insert the time signal lines in Nos. 1 and 3. Then, fix them with the cord holder. In the cases of time signal second circuit and parental function (expanded functions), insert them in Nos. 4 and 5.
4. Set the front case to the unit, insert the connector and close the top cover.

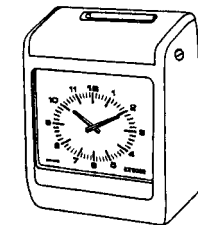
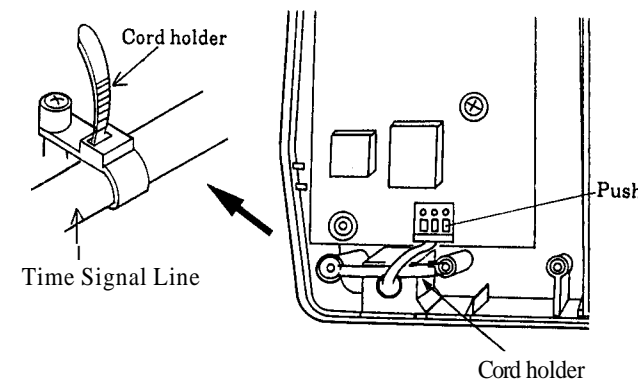

■ Wiring Diagram of Time Signal Line

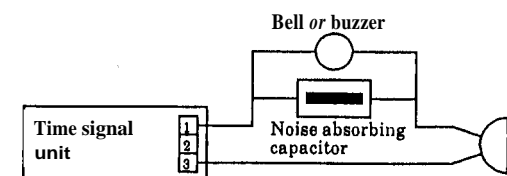

■ Specification for Connection

- Time signal circuit :
 1 circuit (2 circuits can be expanded.)
 Contact capacity :
 250VAC inductive load 0.5A max.
 24VDC inductive load 0.5A max.
 Contact output :
 No-voltage contact output

Include a noise absorbing capacitor (For example, S-1205) in the time signal unit,

SETTING METHOD

Setting

- For program setting, open the top cover, and the setting mode starts. Turn the setting index, press the item button, then start each setting.
- Set all hours on the military hours system.

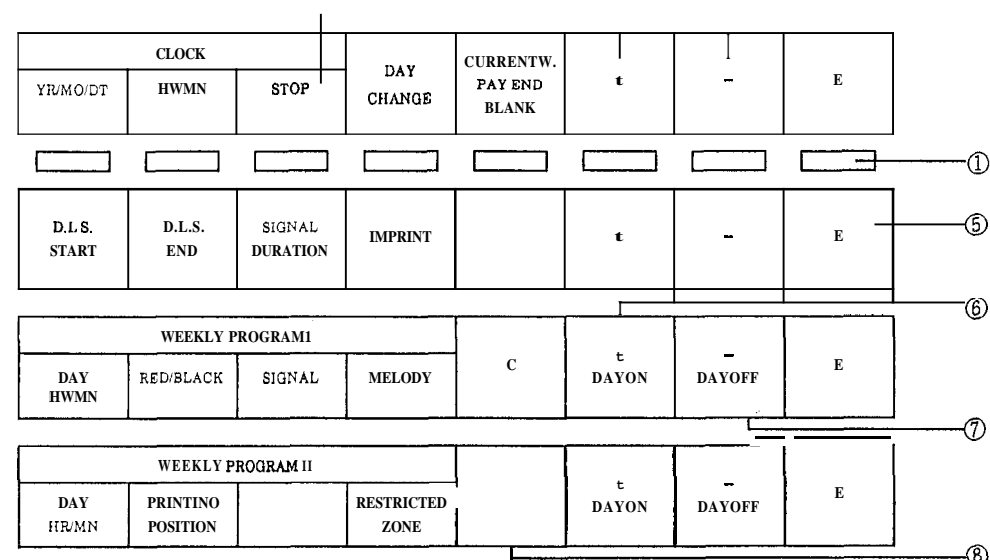

No.	Name	Function
①	Item Button	Press the item button, and each item can be set.
②	STOP Button	The clock stops while the button is pressed, but it starts running when the button is released.
③	+ Button	Press the button once, and the value increases by 1. If you keep pressing the button, the value keeps increasing quickly.
④	- Button	Press the button once, and the value decreases by 1. If you keep pressing the button, the value keeps decreasing quickly.
⑤	E Button	Press the button to restore any value changed by pressing the + or - Button.
⑥	+ DAY ON Button	When this button is pressed while setting a weekly program, a day of the week brinking on the display turns to going on and becomes effective.
⑦	- DAY OFF Button	Whe the button is pressed while setting a weekly program, a day of the week brinking on the display turns to going out and becomes ineffective.
⑧	C Button	Keep pressing the button for more than 2 seconds, and the contents of a weekly program number are erased. (When this button is kept pressing for less than 2 seconds, only the screen is erased, and the contents already set remain.)

- When an item is changed to another during setting, items registered by E button are effective. (Weekly programs are excluded.)
- Starts and ends of Daylight Saving Time and Restricted Zone should be set together at the same time. Also, such setting may not extend beyond the print column changeover time.

Setting of Date

Example : Set "August 11, 1991" on the time recorder.

- Press the YR/MO/DT button, and the present date is indicated.

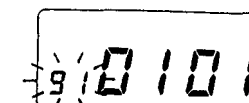

CLOCK			DAY CHANGE	CURRENTW. PAY END BLANK	+	-	E
YR/MO/DT	HWMN	STOP					

- Set "91" to the year by using the + or - button. 00 to 90 represent those of 2000, while 91 to 99 represent those of 1900s.

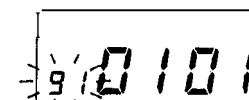

- Press the E button.

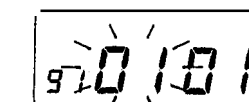

- Set "08" to the month by using the + or - button.



- Press the E button.

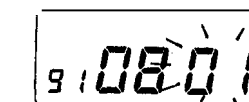

- Set "11" to the day by using the + or - button.

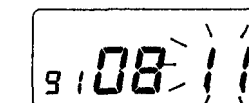

- Press the E button.

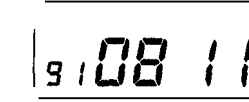

Setting of Time

Example : Set "8:48 a.m." on the time recorder.

1. Press the HR/MN button, and the present time is indicated.

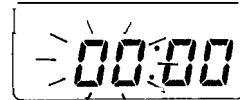

CLOCK			DAY CHANGE	CURRENT W. PAY END BLANK	+	-	E
YR/MO/DT	HR/MN	STOP					

2. Set "08" to the hour by using the + or - button.
Note : Set hours on the military hours system.

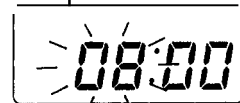

3. Press the E button.

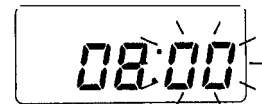

4. Set "48" to the minute by using the + or - button.

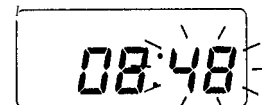

5. Press the E button.
The clock starts running immediately after the button has been pressed.

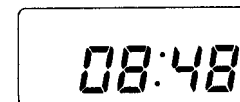

* STOP Button

When the clock is slightly fast, press the STOP button.

The clock stops while the button is pressed and starts running immediately after the button has been released

Print Column Change-over Time (In the case of 1-row-a-day card)

Example : Set the print column change-over time to 4:30.

1. Press the DAY CHANGE button, and the initial value appears.
(03:00)



CLOCK			DAY CHANGE	CURRENT W. PAY END BLANK	+	-	E
YR/MO/DT	HWMN	STOP					

2. Set "04" to the hour by using the + or - button.

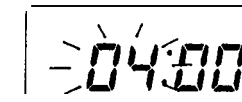

3. Press the E button.

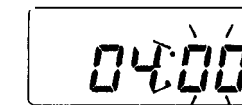

4. Set "30" to the minute by using the + or - button.

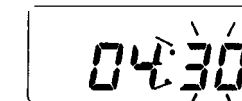

5. Press the E button.

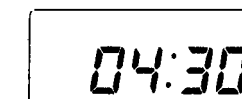

**Print Column and Morning/Afternoon Change-over Time
(In the case of 2-row-a-day card)**

Example : Set the morning/afternoon change-over time to 14:30.

1. Press the DAY CHANGE button, and the initial values appear.
 1 : Division 1 (Date change-over time) 03 :00
 2 : Division 2 (Morning/Afternoon change-over time) 12 :00



CLOCK			DAY CHANGE	CURRENTW. PAY END BLANK	+	-	E
YR/MO/DT	HR/MN	STOP					

2. Set "2" to the division by using the + and - buttons.

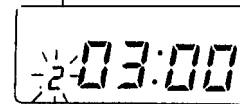

3. Press the E button.
(The initial value for the Division 2 appears.)

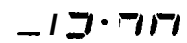

4. Set "14" to the hour by using the + and - buttons.

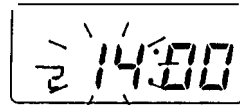

5. Press the E button.

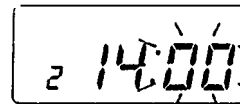

6. Set "30" to the minute by using the + and - buttons.

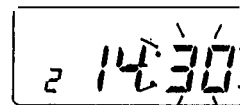

7. Press the E button.

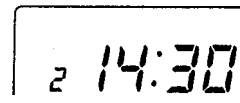

Setting of Pay Period Ending Date and Blank Row (In the case of Monthly Pay)

Example : Set the pay period ending date to the 25th day of a month and a blank row at the 17th row.

CLOCK		DAY	CURRENTW.
YR/MO/DT	HWMN		

2. Set "25" to the pay period ending date by using the + and - buttons.

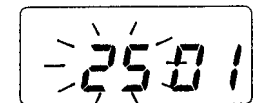

3. Press the E button, and the blank row turns to "17."

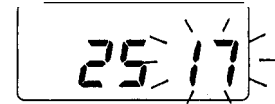

4. Set the blank row by using the + and - buttons.

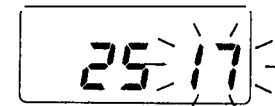

5. Press the E button.

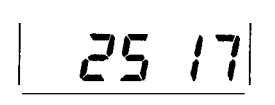

- * Blank Row
The top row of time card is number 01 and the lowest row on the back is numbered 32, and a blank row can be set by designating a number on the card.
- * When a pay period ending date is set to the 20th or 25th day, the blank row automatically turns to "17."
When a pay period ending date is set to any other date, the initial value "1" remains unchanged.

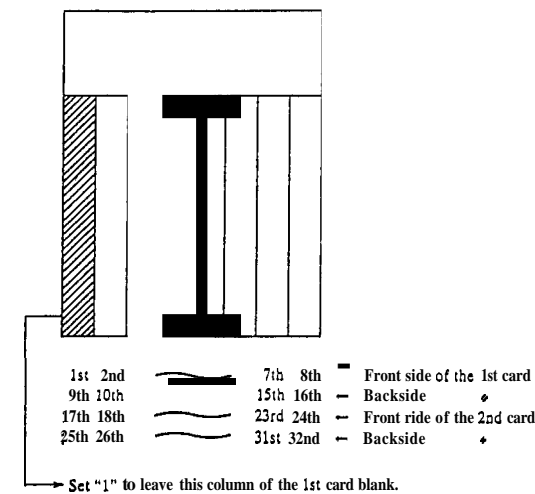
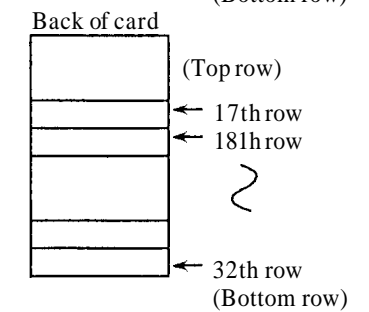
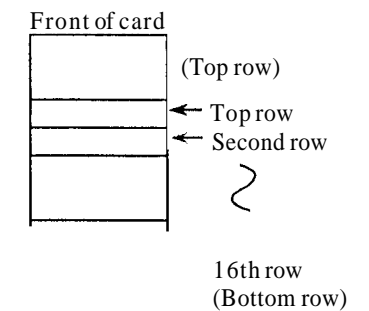

Setting of Pay Period Ending Day of the Week and Current Week
(In the case of Weekly Pay)

Example : Set the pay period ending day of the week to Saturday (bi-weekly pay) and the current week to the second week.

1. Press the CURRENT W. PAY END BLANK button, and the initial values appear. (The pay period ending day of the week is Friday, and the current week is the first one.)

CLOCK			DAY CHANGE	CURRENT W. BLANK	t	-	E
YR/MO/DT	HR/MN	STOP					

2. Set "2" to the current week by using the + and - buttons.
Only bi-weekly pay is set.

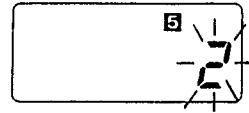

3. Press the E button.

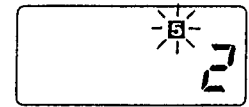

4. Set "6" to the day of the week by using + and - buttons.
① : Monday ② : Tuesday ③ : Wednesday ④ : Thursday
⑤ : Friday ⑥ : Saturday ⑦ : Sunday

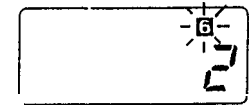

5. Press "E" button.



* When the card specification is set to week pay, the current week is not shown on the display.

Setting of Daylight Saving Time (to month and day)

Example : Set the starting date of daylight saving time to July 5.

1. Press the D.L.S. START button, and the initial value appears.

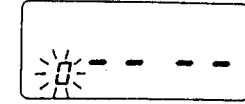

D.L.S. START	D.L.S. END	SIGNAL DURATION	IMPRINT		+	-	E

- 0 : No function
- 1 : Setting of month and date
- 2 : Setting of month and day of the week

2. Select "1" as the setting method of daylight saving time by using the + and - buttons.

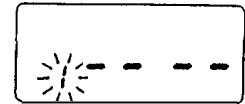

3. Press the E button.



4. Set "07" to the month by using + and - buttons.



5. Press the E button.

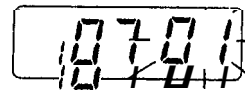

6. Set "05" to the day by using the + and - buttons.

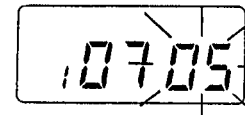

7. Press the E button.

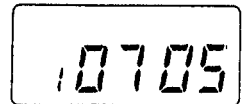

8. Also, set the ending date of daylight saving time in the same way.

- Set both the starting and ending dates of daylight saving time. When only either of them is set, daylight saving time is not set.
- When the starting date and the ending date are set to a same date, the both dates are erased.
- The change-over time for daylight saving time is 2:00 a.m.

Setting of Daylight Saving Time (to month and day of which week)

Example : Set the starting date of daylight saving time to the second Monday of July

1. Press the D.L.S. START button, and the initial value appears.

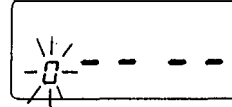

D.L.S. START	D.L.S. END	SIGNAL DURATION	IMPRINT		+	-	E
--------------	------------	-----------------	---------	--	---	---	---

- 1: Setting of month and date
- 2: Setting of month and day of the week

2. Select "2" as the setting method of daylight saving time by using the + and - buttons.

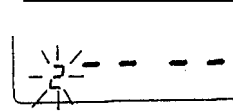

3. Press the E button.

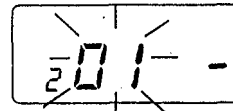

4. Set "07" to the month by using + and - buttons.



5. Press the E button.



6. Set "02" to the week by using + and - buttons.

- 1: 1st week 4: 4th week
- 2: 2nd week 5: 5th week
- 3: 3rd week

Su	Mo	Tu	We	Th	Fr	Sa
					7	8
9	10	11	12	13	14	15
16	17	18	19	20	21	22
23	24	25	26	27	28	29



7. Press the E button.

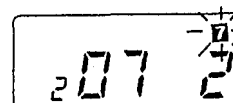

8. Set "1" to the day of the week by using + and - buttons.
 ① : Monday ② : Tuesday ③ : Wednesday ④ : Thursday
 ⑤ : Friday ⑥ : Saturday ⑦ : Sunday



9. Press the E button.

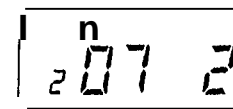

10. Also, set the ending date of daylight saving time in the same way.

- Set both the starting and ending dates of daylight saving time. When only either of them is set, daylight saving time is not set.
- When the starting date and the ending date are set to a same date, the both dates are erased.
- The change-over time for daylight saving time is 2:00 a.m.

Setting of Time Signal Duration <EX9050, EX9200, EX9500 >

Example : Set the time signal duration to 10 seconds.

1. Press the SIGNAL DURATION button, and the initial value appears (for 5 seconds).

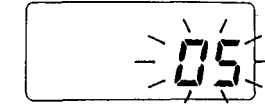

D.L.S. START	D.L.S. END	SIGNAL DURATION	IMPRINT		+	-	E
--------------	------------	-----------------	---------	--	---	---	---

2. Set "10" to the time signal duration by using the + and - buttons. (The setting range extends from 00 to 59 seconds. No time signal is output at 00 second.)

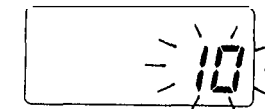

3. Press the E button.



- * Even in the case of 2-circuit output of time signal [Extension], the time signal duration is set to the same length.

Setting of Print Format

Example: Set the print column manual selection to possible, the double printing prevention to effective, indication of day of the week to English, hour indication to the 12 hours (AM/PM hours) and minute indication to the 1/100 hourB.

① Print column manual selection <EX9500> *1 1: Manual selection possible 2: Manual selection impossible (applicable to vertical monthly pay and vertical weekly payonly)	
② Double printing prevention <EX9500> *2 0: Ineffective 1: Effective	
③ Indication of day of the week 0: Date 1: English 2: Spanish 3: French 4: German 5: Italian 6: Japanese 7: Day No. 8: No indication	④ Print format 1: 24 hours (0 - 23 hours) (0 is not printed at the ten's place of hour.) 2: 12 hours (AM/PM hours) 3: 24 hours (0 - 23 hours) (0 is printed at the ten's place of hour.)
⑤ Minute indication 1: Minutes 2: 1/100 Hour A 3: 1/100 Hours B 4: 1/10 Hour	

*1 Print column manual selection <EX9500>

By use of "print column shifting", a printing column other than the preset column may be selected manually.

*2 Double printing prevention <EX9500>

Sometimes it is difficult to identify work beginning time from work ending time. To prevent double printing, print column should be changed over from the work beginning time to work ending time. Otherwise, nothing is printed even if a card is inserted.

* Be cautious that setting the printing column manual selection to impossible and the double printing prevention to effective will make the unit unprintable during working hours.

* In the case of EX9000, EX9050, EX9200 and EX9500 (when horizontal monthly pay and horizontal weekly pay are set), start setting from Procedure 6 below:

1. Press the IMPRINT button, and the initial value appears.

D.L.S. START	D.L.S. END	SIGNAL DURATION	IMPRINT		+	-	E
-----------------	---------------	--------------------	---------	--	---	---	---

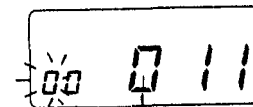

When the card type is weekly pay, the initial value is "1."

2. Set the "print column manual selection" by use of + and - buttons.

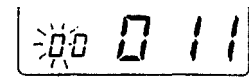

3. Press E button.



4. Set "1" to the double printing prevention by using the + and - buttons. <EX9500>



5. Press the E button.

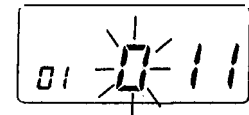

6. Set "1" to the indication of day of the week by using the + and - buttons.
<The following procedures are applicable to all models.>

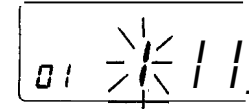

7. Press the E button.

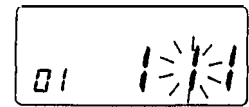

8. Set "2" to the print format by using the + and - buttons.

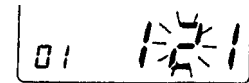

9. Press the E button.

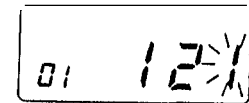

10. Set "3" to minute indication by using the + and - buttons.

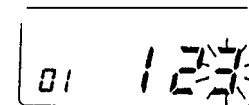

11. Press the E button.

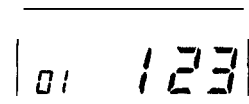

1/100 hour A, 1/100 hour B and 1/10 hour :

Minute	0	1	2	3	4	5	6	7	8	9	~
1/100 hour A	00	02	03	05	07	08	10	12	13	15	-
1/100 hour B	00	00	00	05	05	05	10	10	10	15	-
1/10 hour	0	0	0	0	0	0	1	1	1	1	~

Minute	29	30	31	32	33	34	35	~	54	55	56	57	58	59
1/100 hour A	48	50	52	53	55	57	58	~	90	92	93	95	97	98
1/100 hour B	45	50	50	50	55	55	55	~	90	90	90	95	95	95
1/10 hour	4	5	5	5	5	5	5	~	9	9	9	9	9	9

Setting of 2-color Printing <EX9200, EX9500>

Example : Start 2-color printing at 8:31 a.m. from Monday to Friday.

1. Select WEEKLY PROGRAM I from the setting indexes, and a program No. appears.



WEEKLY PROGRAM I			C	+ DAY ON	- DAY OFF	E
DAY HR/MN	RED/BLACK	SIGNAL				

2. Press the DAY HR/MN button.



3. A day of the week is set as follows:

- ① : Monday ② : Tuesday ③ : Wednesday ④ : Thursday
- ⑤ : Friday ⑥ : Saturday ⑦ : Sunday

When setting a day of the week where the LED goes on and off, press the DAY ON button. In the other cases, press the DAY OFF button.

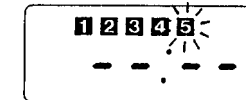

4. To set the time when 2-color printing starts, follow the procedures mentioned in the Paragraph "CLOCK", Page 23.



5. Press the WEEKLY PROGRAM I and the RED/BLACK buttons.

R : Start of printing in red

B : Start of printing in black

Use the + and - buttons to indicate "R", "B" on the display, then press the E button.

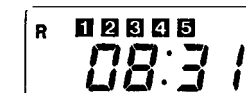

6. Check if the above setting is correct, and press the E button again to register the setting.

(The next program No. is indicated.)

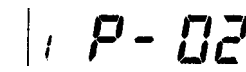

Setting of Time Signai <EX9050, EX9200 and EX9500>

Example : Set a time so that a time signal goes on at 8:30 from Monday to Saturday.

1. Select WEEKLY PROGRAM I from the setting indexes, and a program No. appears.

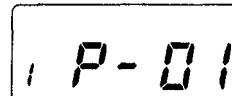

WEEKLY PROGRAM I				C	t DAYON	- DAYOFF	E
DAY HWMN	RED/BLACK	SIGNAL					

2. Press the DAY HR/MN button.

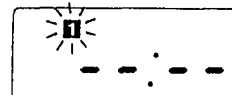

3. A day of the week is set as follows:

① : Monday ② : Tuesday ③ : Wednesday ④ : Thursday
⑤ : Friday ⑥ : Saturday ⑦ : Sunday

When setting a day of the week where the LED goes on and off, press the DAY ON button. In the other cases, press the DAY OFF button.

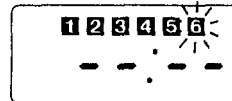

4. To set the time when the time signal goes on, follow the procedures mentioned in the Paragraph "Setting of Time" Page 23.

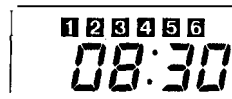

5. Press the WEEKLY PROGRAM I and the SIGNAL buttons.

0: No signal goes on.

1: The signal goes on in Circuit 1.

2: The signal goes on in Circuit 2. [Extension]

3: The signal goes on in both Circuits 1 and 2. [Extension]

Use the + and - buttons to decide the content to be indicated on the display, then press the E button.

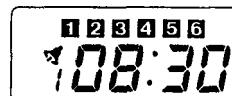

6. Check if the above setting is correct, and press the E button again to register the setting.
(The next program No. is indicated.)



Setting of Print Column <EX9500>

Example : Shift the print column to the Column 4 at 18:00 from Monday to Sunday.

1. Select WEEKLY PROGRAM II from the setting indexes, and a program No. appears.

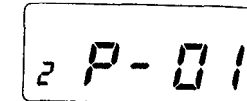

WEEKLY PROGRAM II				C	t DAYON	- DAYOFF	E
DAY HWMN	PRINTING POSITION	RESTRICTED ZONE					

2. Press the DAY HR/MN button.

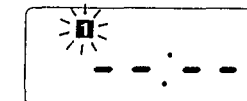

3. A day of the week is set as follows:

① : Monday ② : Tuesday ③ : Wednesday ④ : Thursday
⑤ : Friday ⑥ : Saturday ⑦ : Sunday

When setting a day of the week where the LED goes on and off, press the DAY ON button. In the other cases, press the DAY OFF button.

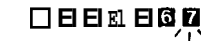

4. To set the time when a print column is shifted, follow the procedures mentioned in the Paragraph "Setting of Time" Page 23.

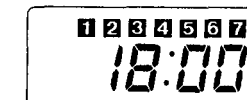

5. Press the WEEKLY PROGRAM II and the PRINTING POSITION buttons to set the position of the column to be shifted to on the display. (00 to the MAX column of each card type)
Use the + and - buttons to position the print column, then press the E button. If the print column shifting is set to "00", the column before printing and after printing stays same without regard to the programming.

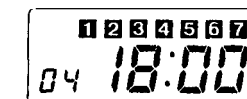

6. Check if the above setting is correct, and press the E button again to register the setting.
(The next program No. is indicated.)

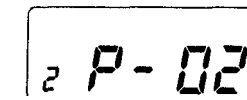

Setting of RESTRICTEDZONE

< EX9500 (Vertical monthly pay and vertical weekly pay) >

Example : Make the Double Printing Prevention effective between 8:31 and 17:00 from Monday to Friday.

1. Select WEEKLY PROGRAM II from the setting indexes, and a program No. appears.

2 P-01

WEEKLY PROGRAM II				+	-	E
DAY HR/MN	PRINTING POSITION	RESTRICTED ZONE				
				DAYON	DAYOFF	

2. Press the DAY HR/MN button.

1 2 3 4 5 6 7

3. A day of the week is set as follows:

① : Monday ② : Tuesday ③ : Wednesday ④ : Thursday
⑤ : Friday ⑥ : Saturday ⑦ : Sunday

When setting a day of the week where the LED goes on and off, press the DAY ON button. In the other cases, press the DAY OFF button.

1 2 3 4 5 6 7

4. To set the time zone during which the double stamping prevention remains effective, follow the procedures mentioned in the Paragraph "Setting of Time" Page 23.

1 2 3 4 5
08:31

5. Press the WEEKLY PROGRAM II and the RESTRICTED ZONE buttons.

01 : Start of double stamping prevention
02 : End of double stamping prevention

Use the + and - buttons to indicate 01 or 02 on the display and press the E button.

1 2 3 4 5
01 08:31

6. Check if the above setting is correct, and press the E button again to register the setting.
(The next program No. is indicated.)

2 P-02

7. Register the ending time (17:00) of double stamping prevention in the same way.

* Be sure to set the starting and ending times of double stamping prevention together at the same time. These times cannot be set when extending beyond a print column change-over time.

Example of Main Settings

Example : Start printing in black and sound a time signal at 17:00 from Monday to Saturday.

1. Select the WEEKLY PROGRAM I, set a day of the week and a time, thence press the E button.

1 2 3 4 5 6
17:00

WEEKLY PROGRAM I				C	+	-	E
DAY HR/MN	RED/BLACK	SIGNAL					
					DAYON	DAYOFF	

2. Press the RED/BLACK button, indicate "B" on the display by using the + and - buttons, then press the E button.

B 1 2 3 4 5 6
17:00

3. Press the SIGNAL button, indicate "1" on the display by using the + and - buttons, thence press the E button.

B 1 2 3 4 5 6
1 17:00

4. Check if the above setting are correct, and press the E button again to register the setting.
(The next program No. appears.)

1 P-05

If the E button is kept being pressed for 2 seconds at this stage, the weekly program is copied.

For the details, see Page 38.

* If you have made a mistake during the setting procedures, press the C button. The function of the C button depends on the length of the time that the C button is kept being pressed.

When the C button has been pressed for less than 2 seconds, P-05 appears on the display (and the program contents remain).

When the C button has been pressed for more than 2 seconds, the contents of relevant program are completely erased.

Example of Main Setting (Copying of Weekly Program)

Copying of Weekly Program:

Details (day of the week and time) set in a program are copied in its next-numbered program. When the next programs have already been set, however, they are copied in the smallest-numbered program not set.

Example : Sound time signals at 9:00 and 12:00 from Monday to Friday.

1. Set a weekly program to sound a time signal at 9:00 in the WEEKLY PROGRAM I.

WEEKLY PROGRAM I				c	t DAYON	- DAYOFF	E
DAY HWMN	RED/BLACK	SIGNAL					

1 2 3 4 5
109:00

2. Keep pressing the E button for 2 seconds, and a number of program, in which the weekly program is copied, appears on the display. (When Program No. 7 is empty.)

1 P-07

3. Release the E button. Then, you will set the time.

1 2 3 4 5
09:00

4. Change the time (to 12:00) and press the E button.

1 2 3 4 5
12:00

5. Set the time signal in the same way as that mentioned in Paragraph "Setting of Time Signal" Page 35, then press the E button.

1 2 3 4 5
112:00

6. Check if the setting is correct, then press the E button again to register the setting. (The next program number appears.)

1 P-08

MODIFICATION OF SET DETAILS OF WEEKLY PROGRAM

Modification (or Confirmation) of Weekly Program

Example : When modifying (confirming) 2-color printing and time signal,

1. Open the top cover and select the WEEKLY PROGRAM I among setting indexes.

1 P-01

WEEKLY PROGRAM I				c	t DAYON	- DAYOFF	E
DAY HWMN	RED/BLACK	SIGNAL					

2. Select a program No. to be modified (or confirmed) by using the + and - buttons.

Example : Program No. 12

1 P-12

3. Press the E button, and the details of the program to be modified (or confirmed) appear on the display.

The details mean to change over to printing in black and to sound a time signal at 17:25 from Monday to Friday.

B 1 2 3 4 5
117:25

4. When modifying the content, press the button of an item to be modified, modify it by using the + and - buttons, then press the E button to register.

Example : Modify so as to change over to printing in black and to sound a time signal at 17:30 from Monday to Friday.

B 1 2 3 4 5
117:30

5. After completion of modification, press the E button, and the next program No. appears on the display. When nothing has been modified in the Procedure 4, press the + button, and the next program No. appears on the display. (Press the - button to indicate the previous program No.)

1 P-13

Additional Setting

1. Open the top cover and select the WEEKLY PROGRAM I among setting indexes.

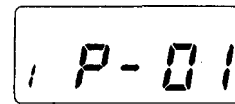

WEEKLY PROGRAM I				C	+ DAYON	- DAYOFF	E
DAY HR/MN	RED/BLACK	SIGNAL					

2. Keep pressing the E button for 2 seconds, and an empty program No. appears on the display.

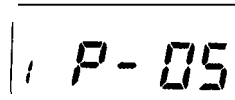

3. To set an additional item, see the WEEKLY PROGRAM from Page 34.

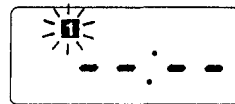

Cancellation of Set Details

1. Open the top cover and select the WEEKLY PROGRAM I among setting indexes.

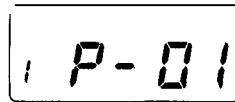

WEEKLY PROGRAM I				C	+ DAYON	- DAYOFF	E
DAY HWMN	RED/BLACK	SIGNAL					

2. Select the program No. to be canceled by using the + and - buttons. (Programs can be canceled even after having displayed the contents by pressing the E button.)
Example : Cancel Program No. 3.

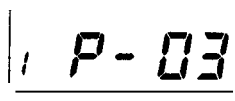

3. Press the C button for 2 seconds (All items go on and off during the time.), and you will hear "Pip!" Now, the cancellation has ended.

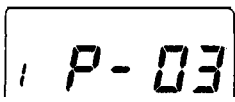

MAINTENANCE

Change of Ribbon

1. Open the top cover, the dot printer head moves to the place where you can change the ribbon.
2. To remove the ribbon, pull the ribbon holder at the end of the ribbon to you, and the ribbon end comes out. So, pull it off.

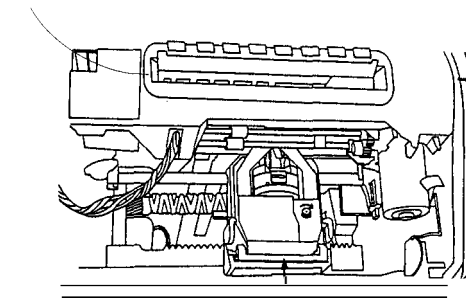
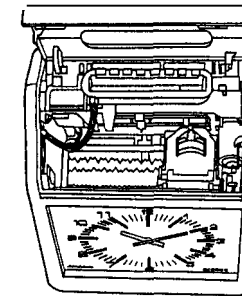

Ribbon holder

3. Set a new ribbon cassette correctly between the ribbon guide and the dot printer head.
4. Turn the knob clockwise, and the ribbon becomes light.

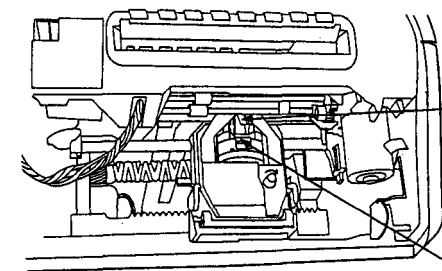

Ribbon guide

Dot printer

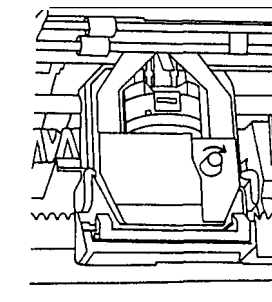

5. Close the top cover.

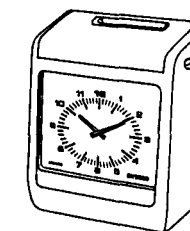

Under Specific Situations

When the error sound goes "Pip, pip, ..." and the attendance/leaving lamp goes out, a trouble has occurred inside the unit. Pull out and disconnect the power cord plug just for once, before inserting back to the receptacle after a little while. In case the unit would not restore the normal state, contact the dealer from whom you have bought the unit.

Under the condition, the clock stops, and no time card cannot be stamped.

Errorcode	Meaning of error	Measures
Err 1	Error of analog clock	Contact the dealer from whom you have bought the unit.
Err 2	Column home position error	
Err 3	Column timing pulse error	
Err 4	Abnormal surface/back sensor level	Set the weekly program again. If it cannot be restored, contact the dealer from whom you have bought the unit.
Err 5	Error of column division sensor	
Err 6	· Malfunction due to external noise · Abnormal set details of weekly program	

Daily Maintenance

Cleaning of case when it becomes dirty:



- Wet a soft cloth with water or neutral detergent and wipe the case lightly with the close.



- Do not use benzine, (volatile) thinner and other chemical for cleaning, but the case may be deformed or discolored.

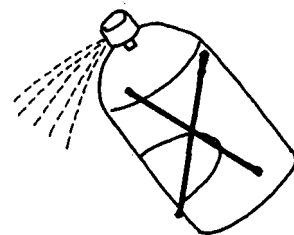

- Do not spray insecticide over the case, but the case may also be deformed or discolored.

Wipe the window glass with a dry soft cloth. Note that the surface is specially finished.

APPENDIX

Index of Items for Setting

- When setting a program, open the top cover and the setting mode appears. Turn the setting index to select items and press items buttons for setting.
- Set all hours and minutes on the military hours system

Items for setting and their explanations are as follows:

Items	Explanation	Page	
Date	To set year, month and day.	22	
Time	To set hour and minute.	23	
Print column change-over (1-row-a-day card)	To set the time for changing over print column.	24	
Print column change-over time, morning/afternoon change-over time (2-row-a-day card)	To set the time for changing over print column and also the time for changing over morning and afternoon.	25	
Pay period ending date, blank row (monthly pay)	To set pay period ending date and blank row in time card.	26	
Pay period ending day of the week, current week (weekly pay)	To set pay period ending day of the week and current week (in the case of bi-weekly pay card).	27	
Daylight saving time (to date)	To set daylight saving time to a designated date.	28	
Daylight saving time (to month and day of which week)	To set daylight saving time to a designated month and day of which week.	29	
Time signal duration	To set the length of time signal.	30	
Print format	To set formats for daily printing (day of the week, 12-hour system or military hours system and minute indication system)	31	
Weekly program I	2-color	To set items changed over to 2-color printing.	34
	Time signal	To set details for sounding time signal.	35
Weekly program II	Print column	To set column No. for shifting column.	36
	RESTRICTED ZONE	To set the time zone of double stamping prevention.	37

Weekly Program Setting List

Example of Entry

PROGRAM NO.	DAY	DAY HR/MN	WEEKLY PROGRAM I		WEEKLY PROGRAM II	
			RED/BLACK	SIGNAL	PRINTING POSITION	RESTRICTED ZONE
01	MOTUWETHFRSA SU	9:01	(R)	B	X	01 02
02	MOTUWETHFRSA SU	17:30	R	(B)	X	01 02

Setting List

PROGRAM NO.	DAY	DAY HR/MN	WEEKLY PROGRAM I		WEEKLY PROGRAM II	
			RED/BLACK	SIGNAL	PRINTING POSITION	RESTRICTED ZONE
01	MOTUWETHFRSA SU	:	R	B		01 02
02	MOTUWETHFRSA SU	:	R	B		01 02
03	MOTUWETHFRSA SU	:	R	B		01 02
04	MOTUWETHFRSA SU	:	R	B		01 02
05	MOTUWETHFRSA SU	:	R	B		01 02
06	MOTUWETHFRSA SU	:	R	B		01 02
07	MOTUWETHFRSA SU	:	R	B		01 02
08	MOTUWETHFRSA SU	:	R	B		01 02
09	MOTUWETHFRSA SU	:	R	B		01 02
10	MOTUWETHFRSA SU	:	R	B		01 02
11	MOTUWETHFRSA SU	:	R	B		01 02
12	MOTUWETHFRSA SU	:	R	B		01 02
13	MOTUWETHFRSA SU	:	R	B		01 02
14	MOTUWETHFRSA SU	:	R	B		01 02
15	MOTUWETHFRSA SU	:	R	B		01 02
16	MOTUWETHFRSA SU	:	R	B		01 02
17	MOTUWETHFRSA SU	:	R	B		01 02
18	MOTUWETHFRSA SU	:	R	B		01 02
19	MOTUWETHFRSA SU	:	R	B		01 02
20	MOTUWETHFRSA SU	:	R	B		01 02
21	MOTUWETHFRSA SU	:	R	B		01 02
22	MOTUWETHFRSA SU	:	R	B		01 02
23	MOTUWETHFRSA SU	:	R	B		01 02
24	MOTUWETHFRSA SU	:	R	B		01 02
25	MOTUWETHFRSA SU	:	R	B		01 02

PROGRAM NO.	DAY	DAY HR/MN	WEEKLY PROGRAM I		PRINTING POSITION	RESTRICTED ZONE
			RED/BLACK	SIGNAL		
26	MOTUWETHFRSA SU	:	R	B		01 02
27	MOTUWETHFRSA SU	:	R	B		01 02
28	MOTUWETHFRSA SU	:	R	B		01 02
29	MOTUWETHFRSA SU	:	R	B		01 02
30	MOTUWETHFRSA SU	:	R	B		01 02
31	MOTUWETHFRSA SU	:	R	B		01 02
32	MOTUWETHFRSA SU	:	R	B		01 02
33	MOTUWETHFRSA SU	:	R	B		01 02
34	MOTUWETHFRSA SU	:	R	B		01 02
35	MOTUWETHFRSA SU	:	R	B		01 02
36	MOTUWETHFRSA SU	:	R	B		01 02
37	MOTUWETHFRSA SU	:	R	B		01 02
38	MOTUWETHFRSA SU	:	R	B		01 02
39	MOTUWETHFRSA SU	:	R	B		01 02
40	MOTUWETHFRSA SU	:	R	B		01 02
41	MOTUWETHFRSA SU	:	R	B		01 02
42	MOTUWETHFRSA SU	:	R	B		01 02
43	MOTUWETHFRSA SU	:	R	B		01 02
44	MOTUWETHFRSA SU	:	R	B		01 02
45	MOTUWETHFRSA SU	:	R	B		01 02
46	MOTUWETHFRSA SU	:	R	B		01 02
47	MOTUWETHFRSA SU	:	R	B		01 02
48	MOTUWETHFRSA SU	:	R	B		01 02
49	MOTUWETHFRSA SU	:	R	B		01 02
50	MOTUWETHFRSA SU	:	R	B		01 02

50 weekly programs can be set at most.

* 2-color printing R : Starting time for changing over to printing in red
B : Time for changing over to printing in black

* RESTRICTED ZONE 01 : Start of double stamping prevention
02 : End of double stamping prevention